



PTO - Power Take Off

Power Take Off

TRT stock a full range of PTO (power take off) solutions from Hydreco Powauto.

Designed to suit all applications, makes and models. Not all PTO options are shown below. For your SOMETHING applications please contact one of our branches.



PA850/851/852 Series

Designed for transmissions with an SAE 8 bolt opening. With heavy duty bearing for high capacity output.

To suit: Eaton Fuller, Mack transmissions.

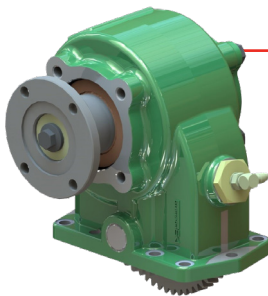

PA28 Series

Low ratio, extra heavy-duty side mounted constant drive.

To suit: Allison 3000, 4000 transmissions.

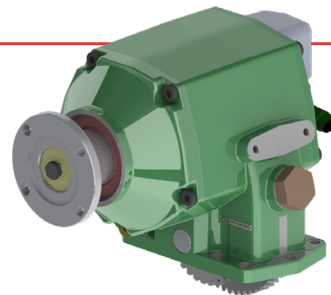

PA38 Series

Low ratio, extra heavy-duty side mounted hot shift for 10 bolt transmissions.

To suit: Allison MD and HD Series transmissions.

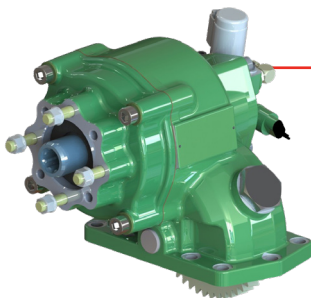

PA41 Series

Low ratio, extra heavy-duty side mounted hot shift for vehicles with a narrow chassis e.g. Hino and Isuzu.

To Suit: Allison MD and HD Series transmissions.

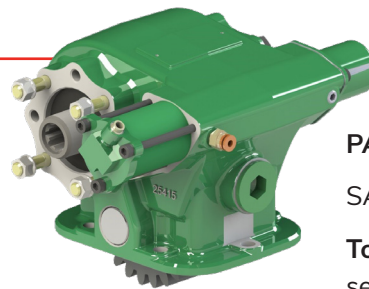

PA78 Series

SAE 6 bolt side mounted.

To Suit: Eaton FS/FSO series transmissions.

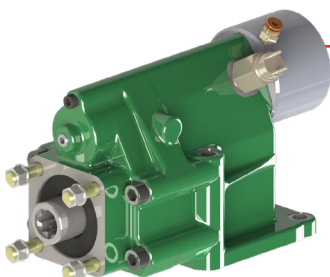

PA368 Series

Heavy-duty 6 bolt side mounted. Operated by air or vacuum.

To suit: Daihatsu, Ford, Hino Isuzu, Mazda, and Toyota transmissions.

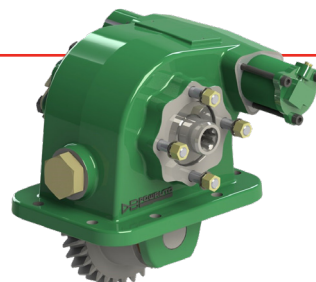

PA371 Series

8 bolt deep rich side mounted.

To suit: certain Isuzu and MLD transmissions.

...for the long haul



PTO

Power Take Off

TRT stock a full range of PTO (power take off) solutions from Hydreco Powauto.

Designed to suit all applications, makes and models. Not all PTO options are shown below. For your SOMETHING applications please contact one of our branches.

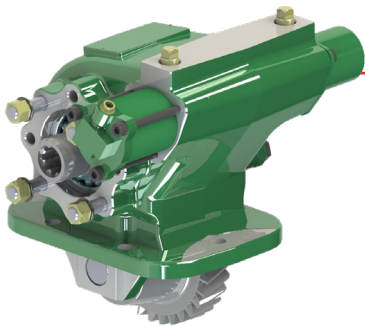

PA393 Series

Heavy-duty 6 bolt side mounted.

To suit: Mitsubishi Fuso transmissions M036S5, M038S5, M038S6.

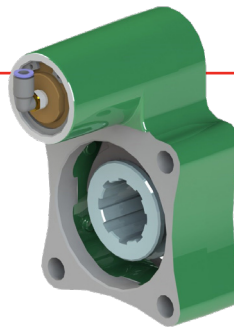

PAB139 Series

4 bolt rear of countershaft.

To suit: ZF and Volvo transmissions.

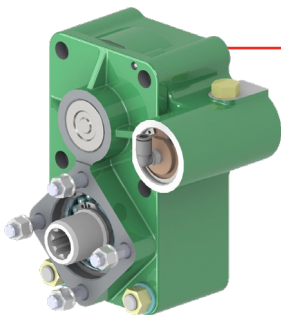

PB 145 Series

Rear mount, commonly used in European trucks.

To suit: Iveco, ZF and Volvo transmissions.

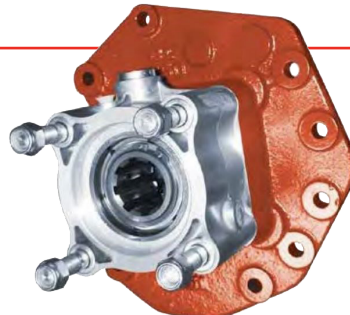

PA 451 Series

Rear mount PTO for Mercedes Benz.

To suit: Mercedes Benz G131, G210, G211, G231, G240, G241, G260, G280, G281, G330



PB 464 | 465 Series

Rear mount PTO for Scania.

To suit: Scania GRS905 and GRSO905.

TRT TIP

Inspect mounting positions and hose connection for oil leaks on a regular basis to prevent pump failure.

...for the long haul