

**U-JOINT IDENTIFICATION**

**INTERNAL CIRCLIP**

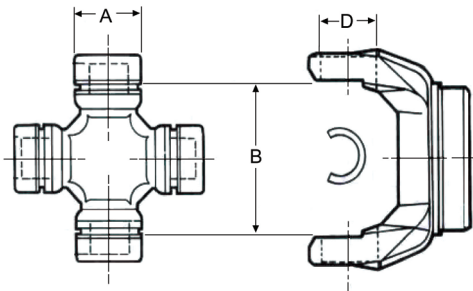

**EXTERNAL CIRCLIP**

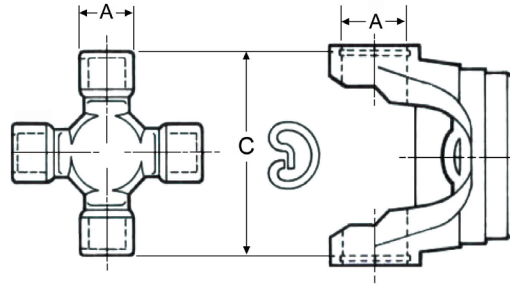

**BEARING PLATE (BP) HALF ROUND (HR) & SPICERLIFE SERIES**

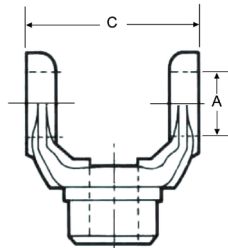
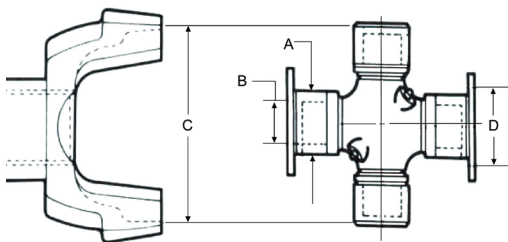

**WING BEARING**

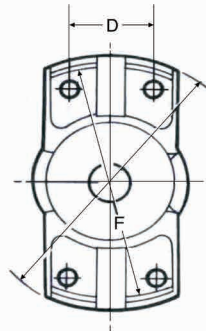
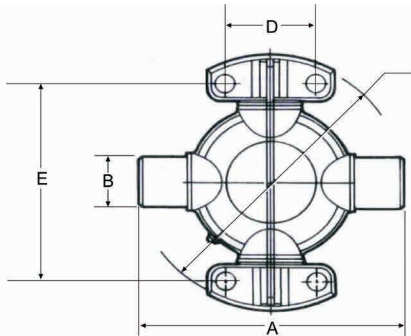

**TRT TIP**

Journal dimensions differ between U joint manufacturers and are not always helpful in identification of a universal joint.

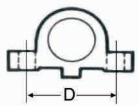

LWD – Low Wing Drilled  
LWT – Low Wing Threaded

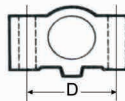

HWD – High Wing Drilled  
HWT – High Wing Threaded

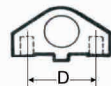

DWT – Delta Wing<sup>®</sup> Threaded



External Circlip



Meritor RPL



Spicer 10 Bearing Plate & Half Round



Internal Circlip



Mechanics Threaded Wing



Mechanics Blocks